

## Hazardous Heavy Duty

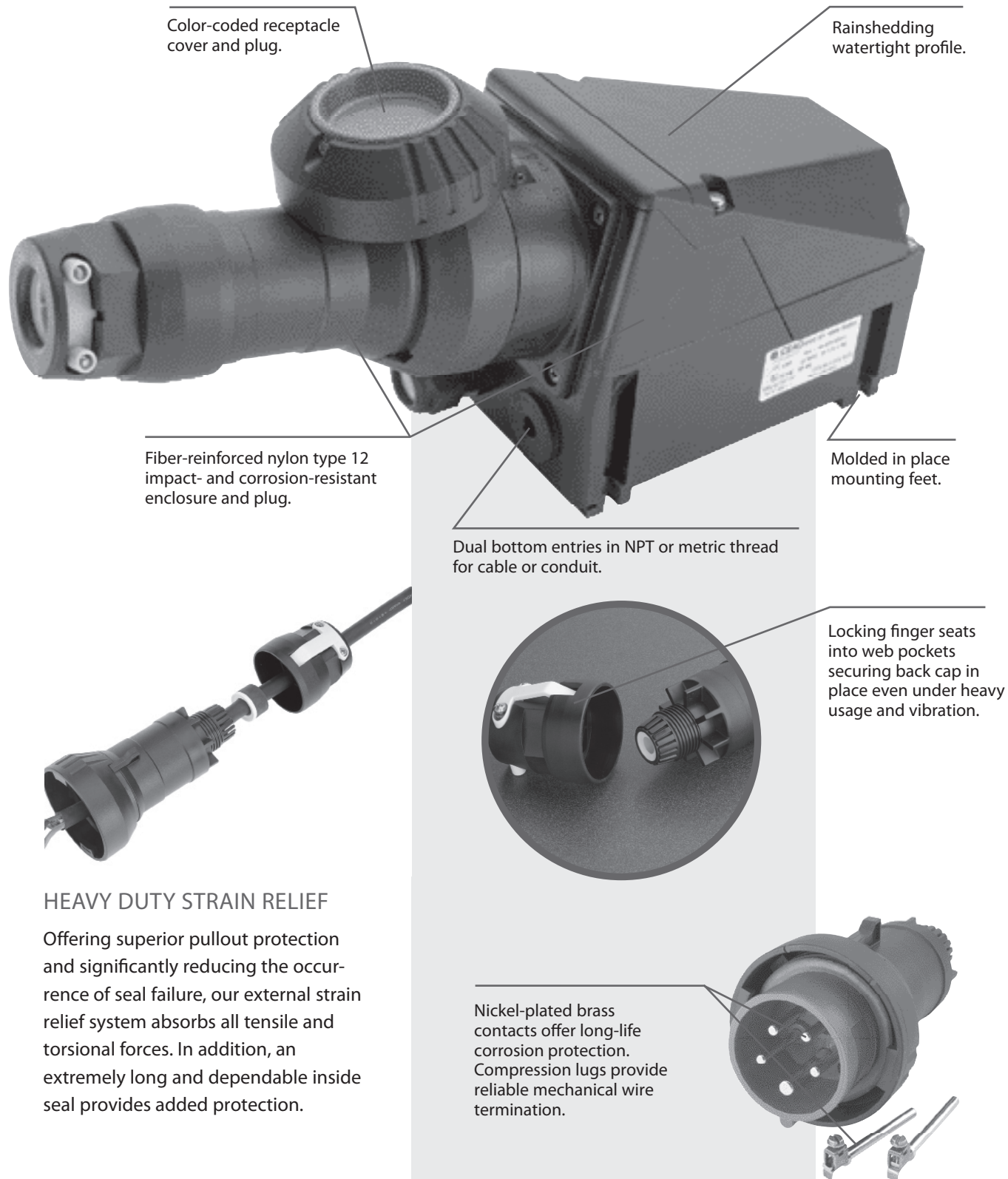

## Hazardous Heavy Duty

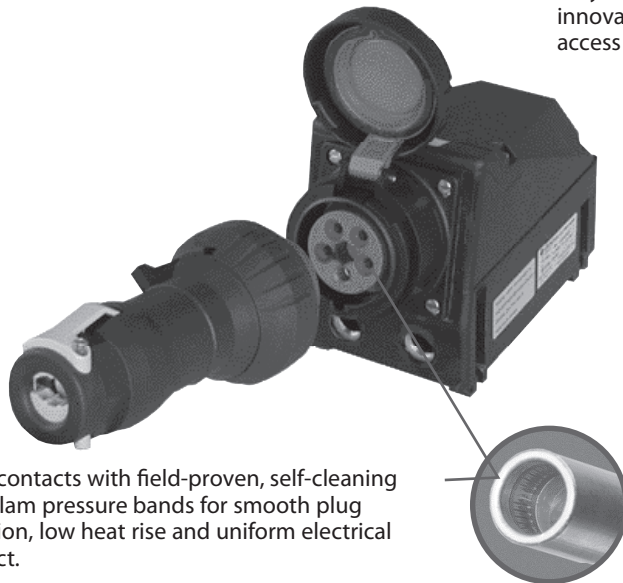

Brass contacts with field-proven, self-cleaning multi-lam pressure bands for smooth plug insertion, low heat rise and uniform electrical contact.

Easy to wire. Cover removes along an innovative break line that permits full access to internal switch terminations.

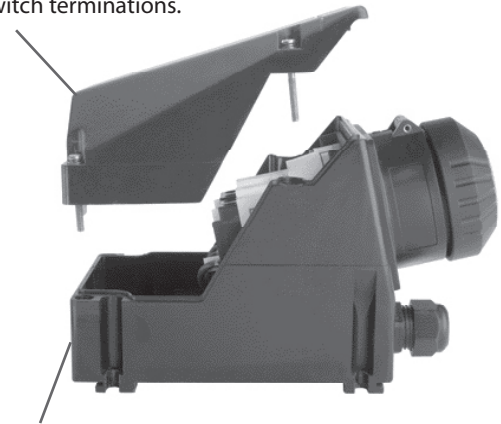

Factory sealed switch provides Zone 1 & 2, Div. 2 explosion protection. Receptacle is dead-front until plug is fully engaged and rotated to activate switch. Plug cannot be removed under load. Switch is horsepower, and AIC-rated.

### Applications:

- Where hazardous gases may be present
- In areas prone to dust, dirt, vibration, hard use, and abuse
- In locations where complete protection against water jets and even temporary flooding is required
- In corrosive environments caused by chemicals, atmospheres, and water
- Ideal for heavy duty industrial applications, such as: chemical plants, mining, drilling, steel/grain/flour mills, pharmaceuticals, portable power

### Features:

- Mechanically interlocked plug and receptacle - plug cannot be engaged or disengaged under load
- Simple "insert plug and twist" design to activate internal switch
- Self-cleaning multi-lam contacts provide reliable power connection
- Compact size, easy to handle and install
- OSHA lockout/tagout
- Dual bottom entry Zone 1 Myers™ Hubs
- Full wiring access, saves time and money
- VØ rated materials

### Certifications and Compliances:

- AEx de IIC T6
- Class I, Zone 1, Division 2, Groups A, B, C, D
- EEx ed IIC T6
- Ⓢ II 2G/D
- UL\*, cUL
- PTB 99 ATEX 1039
- IP66, NEMA 4X
- CE
- VDE
- GOST-R

\*20A, 30A, 60A, 100A Pin Configuration to IEC 309½ Series 2 - UL Listed  
 16A, 32A, 63A, 125A Pin Configuration to IEC 309½ Series 1 - Not UL Listed

### Standard Materials:

- Enclosure - type 12 nylon
- Plug Body - fiber-reinforced nylon
- Hardware - stainless steel
- Contacts - brass

### Options:

<b>Description</b>	<b>Suffix</b>
Auxiliary contacts for PLC or pilot light applications.....	<b>S483</b>



Hazardous Heavy Duty































Hazardous Area Pin and Sleeve Ordering Information:



Amps	Cable Gland	Myers Hub	Wires and Poles	Configuration		Voltage	Interlock Receptacle	Plug
				Receptacle / Connector	Plug / Inlet			
16A	M20		2W3P			110-120	GHG 511 4304 R3001	GHG 511 7304 R0001
	M20		2W3P			220-240	GHG 511 4306 R3001	GHG 511 7306 R0001
	M25		3W4P			220-240	GHG 511 4409 R3001	GHG 511 7409 R0001
	M25		3W4P			380-415	GHG 511 4406 R3001	GHG 511 7406 R0001
	M25		3W4P			500	GHG 511 4407 R3001	GHG 511 7407 R0001
	M25		3W4P			690	GHG 511 4405 R3001	GHG 511 7405 R0001
	M25		4W5P			380-415	GHG 511 4506 R3001	GHG 511 7506 R0001
20A		1/2	2W3P			125	GHG 511 4304 L3001	GHG 511 7304 L0001
		1/2	2W3P			250	GHG 511 4306 L3001	GHG 511 7306 L0001
		3/4	3W4P			3Ø250	GHG 511 4409 L3001	GHG 511 7409 L0001
		3/4	3W4P			3Ø480	GHG 511 4407 L3001	GHG 511 7407 L0001
		3/4	3W4P			3Ø600	GHG 511 4405 L3001	GHG 511 7405 L0001
30A		1	3W4P			3Ø250	GHG 512 4409 L3001	GHG 512 7409 L0001
		1	3W4P			3Ø480	GHG 512 4407 L3001	GHG 512 7407 L0001
		1	3W4P			3Ø600	GHG 512 4405 L3001	GHG 512 7405 L0001
32A	M32		3W4P			220-240	GHG 512 4409 R3001	GHG 512 7409 R0001
	M32		3W4P			380-415	GHG 512 4406 R3001	GHG 512 7406 R0001
	M32		3W4P			500	GHG 512 4407 R3001	GHG 512 7407 R0001
	M32		3W4P			690	GHG 512 4405 R3001	GHG 512 7405 R0001
	M32		4W5P			380-415	GHG 512 4506 R3001	GHG 512 7506 R0001
60A		1 1/4	3W4P			3Ø250	GHG 514 4409 L3001	GHG 514 7409 L0001
		1 1/4	3W4P			3Ø480	GHG 514 4407 L3001	GHG 514 7407 L0001
		1 1/4	3W4P			3Ø600	GHG 514 4405 L3001	GHG 514 7405 L0001

## Hazardous Heavy Duty

### Hazardous Area Pin and Sleeve Ordering Information:

Amps	Cable Gland	Myers Hub	Wires and Poles	Configuration		Voltage	Interlock Receptacle	Plug
				Receptacle / Connector	Plug / Inlet			
63A	M40		3W4P			220-240	<b>GHG 514 4409 R3001</b>	<b>GHG 514 7409 R0001</b>
	M40		3W4P			380-415	<b>GHG 514 4406 R3001</b>	<b>GHG 514 7406 R0001</b>
	M40		3W4P			500	<b>GHG 514 4407 R3001</b>	<b>GHG 514 7407 R0001</b>
	M40		3W4P			690	<b>GHG 514 4405 R3001</b>	<b>GHG 514 7405 R0001</b>
	M40		4W5P			380-415	<b>GHG 514 4506 R3001</b>	<b>GHG 514 7506 R0001</b>
100A		1½	3W4P			125/250	<b>GHG 515 4412 L3001</b>	<b>GHG 515 7412 L0001</b>
		1½	3W4P			3Ø250	<b>GHG 515 4409 L3001</b>	<b>GHG 515 7409 L0001</b>
		1½	3W4P			3Ø480	<b>GHG 515 4407 L3001</b>	<b>GHG 515 7407 L0001</b>
		1½	3W4P			3Ø600	<b>GHG 515 4405 L3001</b>	<b>GHG 515 7405 L0001</b>
		1½	4W5P			230-400	<b>GHG 515 4506 L3001</b>	<b>GHG 515 7506 L0001</b>
125A	M63		3W4P			220-240	<b>GHG 515 4409 R3001</b>	<b>GHG 515 7409 R0001</b>
	M63		3W4P			380-415	<b>GHG 515 4406 R3001</b>	<b>GHG 515 7406 R0001</b>
	M63		3W4P			500	<b>GHG 515 4407 R3001</b>	<b>GHG 515 7407 R0001</b>
	M63		3W4P			690	<b>GHG 515 4405 R3001</b>	<b>GHG 515 7405 R0001</b>
	M63		4W5P			380-415	<b>GHG 515 4506 R3001</b>	<b>GHG 515 7506 R0001</b>



**Hazardous Heavy Duty**

**Hazardous Interlock Receptacle Dimensions**

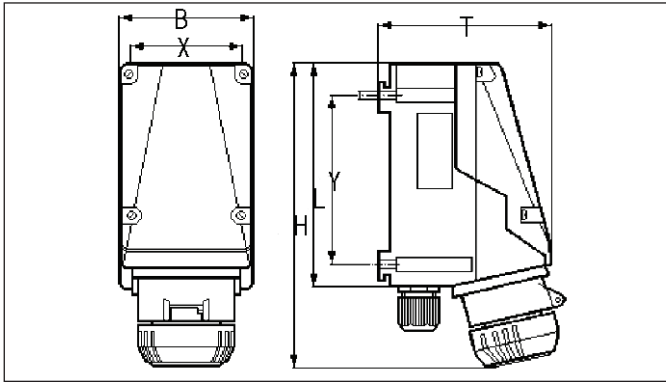

	16/20A		30/32A	60/63A	
	3P	4/5P	4/5P	4/5P	100/125A
B	3.50	4.30	4.70	7.90	8.90
X	3.15	3.94	4.33	7.09	8.10
T	4.80	5.80	6.60	8.90	10.00
Y	4.53	5.31	6.70	10.87	11.90
L	6.10	6.90	8.10	14.60	13.30
H	8.80	9.30	11.50	18.70	21.10

**Hazardous Plug Dimensions**

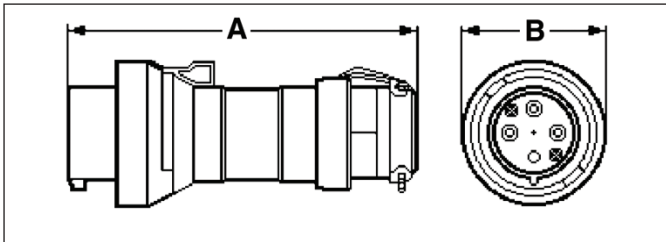

	16/20A			30/32A	60/63A	
	3P	4P	5P	4/5P	4/5P	100/125A
A	6.70	7.40	7.40	9.80	10.70	12.32
B	2.80	3.00	3.30	3.90	4.30	5.16
Cord Dia. Range (In.)	0.515-0.827			0.515-1.102	0.630-1.378	0.827-2.28

**Additional Products**

10A and 20A multi-pin interlock receptacle and plugs are available - please contact factory for ordering information.



16A and 32A flange receptacles and connectors are available - please contact factory for ordering information.

